

Type T Cast Construction

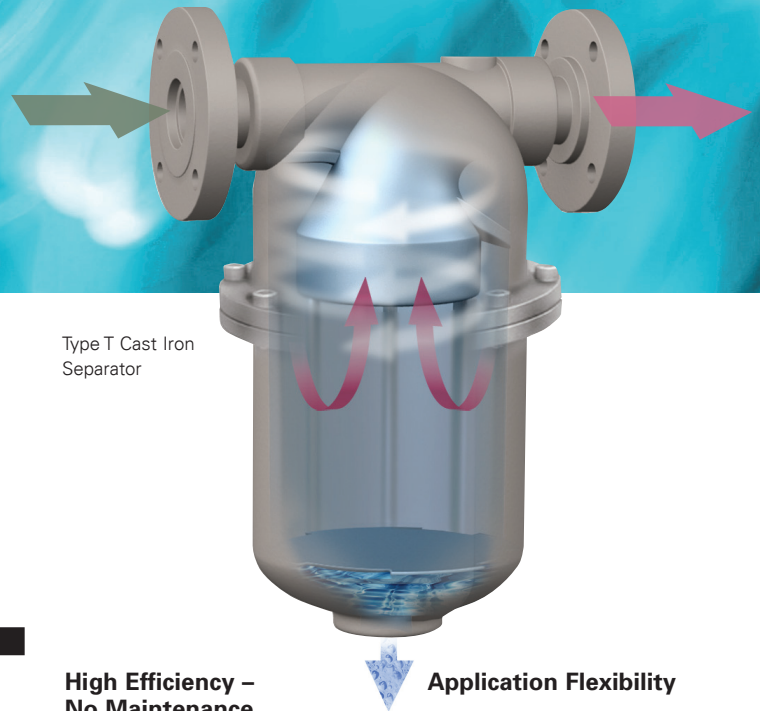

Type T Cast Iron Separator

- Sizes 1" to 5"
- Threaded, Flanged, or Socket Weld
- Cast Iron, Cast Carbon Steel, or Cast Stainless Steel

FEATURES

- Cast Construction
- High Efficiency Over Wide Flow Range
- No Required Maintenance
- Economical Choice for Most Applications
- Removes 99% of Liquid and Solid Entrainment Particles Larger Than 10 Microns
- Gas, Steam, or Air Applications

OPTIONS

- Integral Trap
- Trap Heating Element
- ASME UM or U Code Stamp (CS and SS Models Only)
- Water Gauge Tap
- Thermometer Tap
- Larger Drain Size

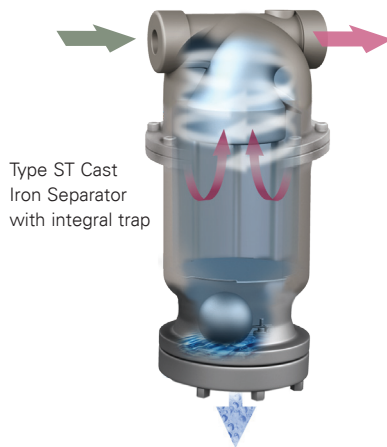

Type ST Cast Iron Separator with integral trap

High Efficiency – No Maintenance

The Eaton Type T Gas/Liquid Separator automatically removes 99% of all liquid and solid entrainment particles 10 microns in size or larger from air, gas, and steam processes. And it does so with no moving parts to wear out and no required maintenance. The Type T, with its cost-effective design, is the separator of choice for most applications that require clean, dry air, gas or steam.

Exclusive Design

Moisture-laden gas enters the inlet of the separator where it is deflected in a centrifugal downward motion. The entrained solids and moisture droplets are separated out by a reduction in velocity. Separated liquid and solids fall into a reservoir where the exclusive Vortex Containment Plate (VCP) ensures that they cannot be re-entrained. The clean, dry flow is then directed to the outlet by the VCP. This eliminates the need for expensive, delicate baffles used in ordinary separators.

Application Flexibility

The basic Type T Gas/Liquid Separator's straightforward, time-proven design fits most applications without options. For more specialized applications, the Type T is available as the Type ST with an integral trap as part of its design. The trap mechanism is a foolproof design which automatically ejects the condensate, without loss of line pressure, when it reaches a predetermined level. The Type ST is compact, easily installed, and can be supported by the line. Removal of the bottom flange releases the trap mechanism for inspection. The internal trap components are rust-proof stainless steel and include a nonmagnetic 18-8 stainless steel valve and seat. For applications below freezing, the Type ST Separator can be ordered as the Type STH that includes a heater for the trap. The heater is rated at 50W and runs with 110 volt service. The self-limiting heating element will keep fluid above freezing but does not add to the line temperature. The heater can be easily removed for inspection.



Powering Business Worldwide

Type T Cast Gas/Liquid Separators

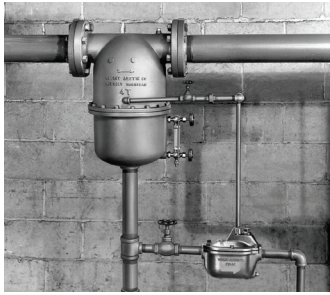

Typical Installation

Selection Table

Pipe Size (in)	Material	Connection	Rating
3/4 to 3	Cast Iron	Threaded	250 psi @ 450°F
2 to 4	Cast Iron	Flanged 125# FF	150 psi @ 353°F 125 psi @ 450°F
1 to 2	Cast Carbon Steel	Threaded or Socket Weld	1000 psi @ 650°F
1 to 2	Cast Stainless Steel	Threaded or Socket Weld	500 psi @ 300°F
1 to 24	Fabricated CS or SS	Flanged 150# RF Flanged 300# RF	150 psi @ 450°F 500 psi @ 650°F

TYPE T Cast Iron Threaded

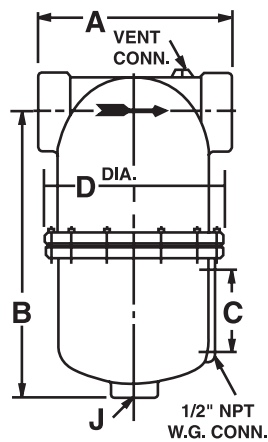

TYPE T Cast Iron Flanged

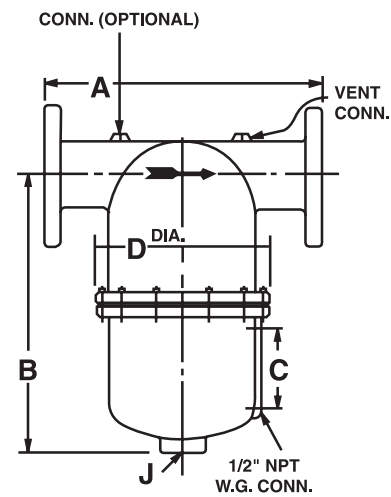

Dimensions - Type T Threaded (Cast Iron) - (in/mm)

Pipe Size	A	B	C	D	J - NPT Drains		NPT Vent	Weight (lb/kg)
					Regular	Optional		
3/4	5.50 / 40	9.19 / 233	-	5.75 / 146	3/4	-	1/4	22 / 10
1	6.00 / 152	9.00 / 229	-	6.75 / 171	1	1-1/4	1/4	25 / 11.4
1-1/4	6.00 / 152	9.13 / 232	-	7.00 / 178	1	1-1/4	1/4	28 / 12.7
1-1/2	7.25 / 184	11.69 / 297	-	8.13 / 207	1	1-1/2	1/4	44 / 20
2	8.13 / 206	13.69 / 348	-	8.50 / 216	1	2	1/4	47 / 21.3
2-1/2	12.00 / 305	15.94 / 405	3.50 / 89	11.38 / 289	1-1/4	2	1/4	89 / 40
3	11.00 / 281	15.94 / 405	3.50 / 89	11.38 / 289	1-1/4	2-1/2	1/4	107 / 48

Dimensions - Type T Flanged (Cast Iron) - (in/mm)

Pipe Size	A	B	C	D	J - NPT Drains		NPT Vent	Weight (lb/kg)
					Regular	Optional		
2	10.50 / 267	13.75 / 349	-	8.50 / 216	1	2	1/4	59 / 27
3	14.00 / 356	16.00 / 406	3.50 / 89	11.38 / 289	1-1/4	2-1/2	1/4	130 / 59
4	15.88 / 403	19.38 / 492	5.00 / 127	14.06 / 357	1-1/4	2-1/2	1/4	195 / 88.6
5	18.38 / 467	24.63 / 626	7.88 / 200	17 / 432	1-1/2		1/4	370 / 168

Note: Threaded ends, NPT, Material ASTM A-278. Flanged ends, 125 lb ANSI flat face and drilling, Material ASTM A-278

Cast Carbon Steel or Cast Stainless Steel Construction

Type T Gas/Liquid Separators are available in 1", 1-1/4", 1-1/2", and 2" sizes in cast carbon steel or cast stainless steel with standard configurations. Cast construction separators are readily available but not easy or cost effective to modify to conform to special application requirements. For these applications, see Fabricated Type T Separators which are made of carbon or stainless steel in sizes up to 24". Fabricated separators are not as heavy as cast ones, an important consideration in applications when weight is a concern.

Capacities – Maximum Air Flow Rating in SCFM

Pipe Size	25 psig	50 psig	100 psig	150 psig	200 psig	250 psig
3/4	55	75	105	125	150	170
1	82	110	155	190	220	255
1-1/4	130	175	245	300	345	400
1-1/2	185	245	345	425	485	560
2	330	445	620	770	870	1000
2-1/2	500	680	945	1170	1350	1550
3	750	1000	1400	1750	1950	2300
4	1325	1775	2500	3075	3600	4000
5	2050	2750	3800	4750	5200	6000
Rated ΔP (psi)	0.88	0.99	1.19	1.40	1.60	1.85

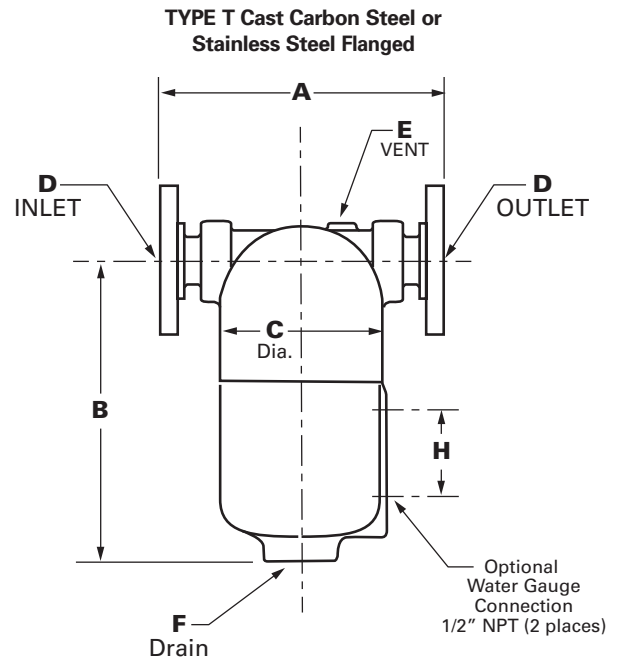
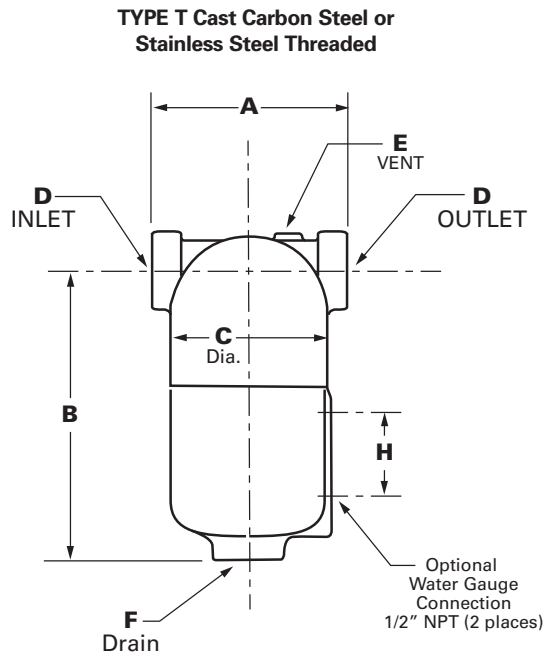

Dimensions: Type T Cast Threaded or Socket Weld - (in/mm)

Pipe Size	A	B	C	D	E	F	H	Weight (lb/kg)
1	6.38 / 161	10.50 / 267	5.56 / 141	1 / 25	1/4	1	4.75	25 / 11.4
1-1/4	6.38 / 161	10.50 / 267	5.56 / 141	1-1/4 / 32	1/4	1	4.75	28 / 12.7
1-1/2	7.63 / 194	12.50 / 317	6.63 / 168	1-1/2 / 40	1/4	1	4.75	44 / 20
2	7.63 / 194	12.50 / 317	6.63 / 168	2 / 50	1/4	1	4.75	47 / 21.3

Note: Threaded ends, NPT, Material ASTM A-278

Dimensions: Type T Cast Flanged - (in/mm)

Pipe Size	A	B	C	D	E	F	H	Weight (lb/kg)
1	10.50 / 267	10.50 / 267	5.56 / 141	1 / 25	1/4	1	4.75	29 / 13
1-1/4	10.50 / 267	10.50 / 267	5.56 / 141	1-1/4 / 32	1/4	1	4.75	30 / 13.6
1-1/2	11.50 / 292	12.50 / 317	6.63 / 168	1-1/2 / 40	1/4	1	4.75	53 / 24
2	11.50 / 292	12.50 / 317	6.63 / 168	2 / 50	1/4	1	4.75	57 / 25.8

Note: Flanged ends, 125 lb ANSI flat face and drilling, Material ASTM A-278.

Type T Cast Gas/Liquid Separators

TYPE ST & STH Cast Iron Threaded

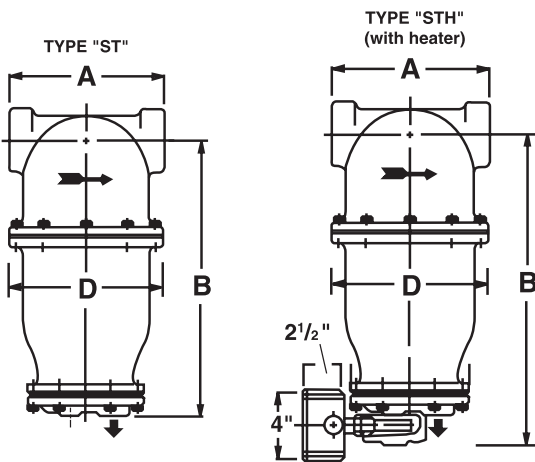

TYPE ST & STH Cast Iron Flanged

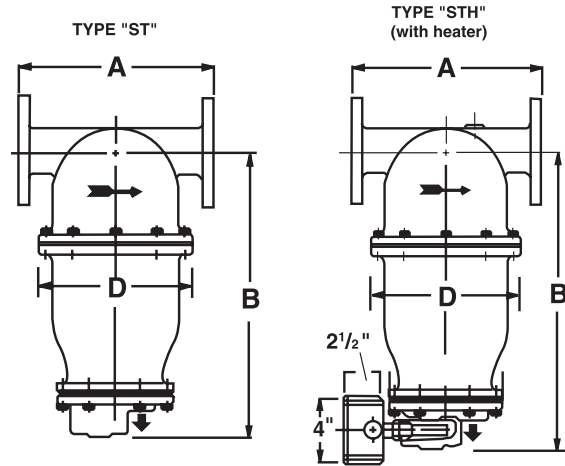

Dimensions - Type ST & STH - Threaded Inlet & Outlet (in / mm)

Pipe Size	A	B (ST)	D	Drain NPT	Vent NPT	Wt (lb/kg) ST	Wt (lb/kg) STH
3/4	5.5 / 40	11.69 / 297	6.75 / 171	3/4	1/4	31 / 14.1	31 / 14
1	6.0 / 152	10.25 / 260	6.75 / 171	3/4	1/4	39 / 17.7	41 / 18.7
1-1/4	6.0 / 152	12.25 / 311	7.00 / 178	3/4	1/4	47 / 21.3	50 / 22.3
1-1/2	7.25 / 184	14.06 / 357	8.13 / 207	3/4	1/4	53 / 24	53 / 24
2	8.13 / 206	14.94 / 380	8.50 / 216	3/4	1/4	58 / 26.3	58 / 26
2-1/2	12.00 / 305	20.44 / 520	11.38 / 289	3/4	1/4	109 / 29.5	109 / 50
3	11.00 / 280	22.44 / 570	11.38 / 289	3/4	1/4	105 / 47.7	108 / 48.7

Note: For steam service use hard valve seat only

TYPE ST 3/4" Cast Iron Threaded

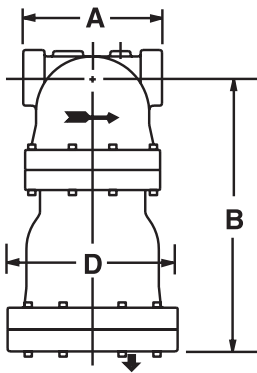

Dimensions - Type ST & STH - 125# Flanged Inlet & Outlet (in / mm)

Pipe Size	A	B (ST)	D	Drain NPT	Vent NPT	Wt (lb/kg) ST	Wt (lb/kg) STH
2	10.50 / 267	15.31 / 389	8.50 / 216	3/4	1/4	51 / 23.2	54 / 24.2
3	14.00 / 356	20.44 / 519	11.38 / 289	3/4	1/4	100 / 45.5	103 / 46.5
4	15.88 / 403	23.50 / 597	14.06 / 357	3/4	1/4	225 / 102.3	228 / 103.3
5	18.38 / 467	31 / 787	17 / 432	3/4	1/4	390 / 177	393 / 178

North America – HQ

70 Wood Avenue, South
2nd Floor
Iselin, NJ 08830

Toll Free: (800) 656-3344
(North America only)

Voice: (732) 767-4200

Brazil

Voice: +55 (11) 2465-8822

China

Voice: +86-21-5200-0099

Europe/Africa/Middle East

Voice: +49-2486-809-0

Singapore

Voice: +65-6825-1668

©2012 Eaton Corporation. All Rights Reserved. All trademarks and registered trademarks are the property of their respective owners. Litho USA. All information and recommendations appearing in this brochure concerning the use of products described herein are based on tests believed to be reliable. However, it is the user's responsibility to determine the suitability for his own use of such products. Since the actual use by others is beyond our control, no guarantee, expressed or implied, is made by Eaton as to the effects of such use or the results to be obtained. Eaton assumes no liability arising out of the use by others of such products. Nor is the information herein to be construed as absolutely complete, since additional information may be necessary or desirable when particular or exceptional conditions or circumstances exist or because of applicable laws or government regulations.

For more information, e-mail us at filtration@eaton.com, or call 732-767-4200.

Visit us online at eaton.com/filtration for a complete list of Eaton's filtration products.



Powering Business Worldwide



EF-G/L-2
6-2012